

USER'S MANUAL

YYJ25065-1



**Installation and usage video
SKU:YYJ25065-1**

Due to the special restrictions of the express delivery company on the product, please contact us promptly if there are any after-sales issues.

Contact Us!

Do NOT return this item.



HZKJservice@gmail.com

Please give us a chance to make it right and do better !

Contact our friendly customer service department for help first.

Replacements for missing or damaged parts will be shipped ASAP !

THIS INSTRUCTION BOOKLET CONTAINS **IMPORTANT** SAFETY INFORMATION. PLEASE READ AND KEEP FOR FUTURE REFERENCE.

READ THIS MANUAL CAREFULLY BEFORE USE – FAILURE TO DO SO MAY RESULT IN INJURY, PROPERTY DAMAGE AND MAY VOID WARRANTY. • KEEP THIS MANUAL FOR FUTURE REFERENCE. • Products covered by this manual may vary in appearance, assembly, inclusions, specifications, description, and packaging.

SAFETY RULES FOR PETROL BLOWERS

TRAINING

- Read the instructions carefully. Get familiar with the controls and proper use of the equipment.
- Only use the blower for the purpose for which it was designed, i.e. blowing garden debris. Any other use can be hazardous, causing damage to the machine.
- Never allow children or people unfamiliar with these instructions to use the blower. Local regulations may restrict the age of the operator.
- Never use the blower:
 - When people, especially children, or pets are nearby.
 - If the operator has taken medicine or substances that can affect his ability to react and concentrate.
- Remember that the operator or user is responsible for accidents or hazards occurring to other people or their property.
- Do not use the unit around people with long hair.

PREPARATION

WARNING! Dress appropriately

- Do not operate with loose clothing or long hair. These can be sucked into the air intake of the blower.
- While blowing, always wear sturdy footwear and long trousers. Do not operate the equipment with bare feet or open sandals.

DANGER! Fuel for the engine is highly flammable.

- Store fuel in containers specifically designed for this purpose.
- Refuel using a funnel and outdoors only. Do not smoke while re-fuelling or whenever handling the fuel.
- Add fuel before starting the engine. Never remove the cap of the fuel tank or add fuel while the engine is running or when the engine is hot.
- If fuel is spilled, do not attempt to start the engine but move the machine away from the area of spillage and avoid creating any source of ignition until the fuel has evaporated and the vapour dispersed.
- Fit all tanks and containers fuel caps securely.
- Before use, always inspect the machine and check for screws that are not loose or worn.
- Wear suitable eye and ear protection when operating the blower.

MAINTENANCE AND STORAGE

WARNING! Do not use the equipment with worn or damaged parts.

- Parts are to be replaced and not repaired. Parts that are not of the same quality can damage the equipment and be dangerous for your safety.
- Keep all nuts, bolts and screws tight to be sure the equipment is in safe working condition. Regular maintenance is essential for safety and performance.
- Never store the equipment with fuel in the tank inside a building where vapour may reach a flame, a spark or a source of extreme heat.
- Allow the engine to cool before storing in an enclosed space.
- To reduce the fire hazard, keep the engine, muffler, and fuel storage area free of grass, leaves, or excessive grease.
- If the fuel tank has to be drained, this should be done outdoors and when the engine is cool.
- Fuel goes stale quickly. If you find your blower does not start, 1st change the fuel in the tank with newly purchased fuel.

SERVICE

- Have your power tool serviced by a qualified repair personnel using only identical replacement parts. This will ensure that the safety of the power tool is maintained.

OPERATION SAFETY INSTRUCTIONS WARNING!

Stop the engine and unplug the spark plug before any repairs or maintenance operations.

- Check that all nuts, bolts and screws are well tightened before every use.
- Do not run the engine in an enclosed and/or poorly ventilated area. The exhaust gas from the engine contains carbon monoxide, which is dangerous.
- Work only when there is sufficient light.
- Do not use the blower when it is raining or when the grass is wet.
- Caution must be taken while blowing on slopes.
- Turn off the engine if you must leave the blower unattended.
- Never change the rated speed of the engine in any way.
- Stop the engine and remove the spark plug cover in these cases:
 - Before any maintenance, repairing or checking operations.
 - If you leave the blower unattended.
 - if the blower vibrates in an abnormal way, take the blower to an authorised service centre.

WARNING! Fuel is highly flammable.

- Keep fuel in a suitable container specially made for this purpose.
- Fill the fuel tank with a funnel and outside. Do not smoke or use a mobile phone.
- Fill with fuel and oil before starting the engine.
- Never open the cap of the fuel tank to add fuel while the engine is running or still hot.
- Do not start the engine if there is spilt fuel on the blower or in the area surrounding. Take the blower away from the area where fuel has been split and avoid any contact from a heat source as long as the spilt fuel is completely evaporated.
- Tighten the fuel tank cap and fuel container cap tightly.

ADDITIONAL SAFETY RULES FOR PETROL BLOWERS

WARNING! Dress appropriately

- Do not operate with loose clothing or long hair. These can be sucked into the air intake of the blower.
- While blowing, always wear sturdy footwear and long trousers. Do not operate the equipment with bare feet or open sandals.
- Do not operate in a hazardous location. Such areas include where there is a risk of explosion of fumes, leaking gas or explosive dust.
- Do not operate in a confined area. Exhaust gases, smoke or fumes could reach dangerous concentrations.
- Protect your blower. This blower is NOT WEATHERPROOF and should not be exposed to direct sunlight, high ambient temperature and damp, wet or high humidity conditions.
- Do not smoke or use a mobile phone while refuelling. This is potentially dangerous as it may ignite the fuel and cause an explosion.
- Take care not to spill fuel. When refuelling the blower ensure that the motor has been switched off. Prevent the spilling of fuel as this may also ignite with the hot motor. Never refuel whilst the engine running.
- Be careful where you store the blower. Store the blower in a dry area away from flammable liquids.
- Keep your distance. The blower emits exhaust fumes. Ensure bystanders keep a safe distance.
- Ensure you use fuel oil mix. Ensure that you mix 30 parts unleaded fuel to 1 part two stroke oil. If not, the engine will overheat and cause damage to your blower.
- Never fill fuel tank indoors. Never fill fuel tank when engine is running or hot. Stop the engine before re-fuelling.
- Stop the engine and disconnect the spark plug wire If the blower starts to vibrate abnormally (find and remove the cause of the vibration immediately).
- Reduce the throttle before turning off the engine and turn the fuel off when you have finished blowing.
- The user is responsible for the safety of other people, animals and objects in the working area. Keep children and domestic animals at a safe distance while the blower is in use.

IMPORTANT NOTE !!!!!

This blower has 2 safety interlocks fitted.

If the Blower tubes or the side grill are not correctly fitted then the **BLOWER WILL NOT START**

ATTENTION STATEMENTS

This manual contains special "attention statements" surrounded by boxes and preceded by the triangular Attention Symbol.



WARNING!

A statement preceded by the word "WARNING" contains information that should be acted upon to prevent serious bodily injury.



WARNING!

A statement preceded by the word "CAUTION" contains information that should be acted upon to prevent machine damage.

Additional attention statements that are not preceded by the Attention Symbol are:

IMPORTANT !

A statement preceded by the word "IMPORTANT" is one that possesses special significance.

NOTE:

A statement preceded by the word "NOTE" contains information that is handy to know and may make your job easier.



Read and follow this manual. Failure to do so could result in serious injury.



Wear eye and hearing protection at all times during the operation of this machine



DO not operate this machine if you are tired, ill or under the influences of alcohol, drugs, or Medicine.

IMPORTANT!

The operational procedures described in this manual are intended to help you get the most from your machine and also to protect you and others from harm. These procedures are general guidelines only, and are not intended to replace any safety rules/laws that may be in force in your area.

If you have any questions regarding your GEB260 blower, or if you do not understand something in this manual, your dealer will be glad to assist you.



WARNING!

Do not make unauthorized modifications to this machine!

NOMENCLATURE

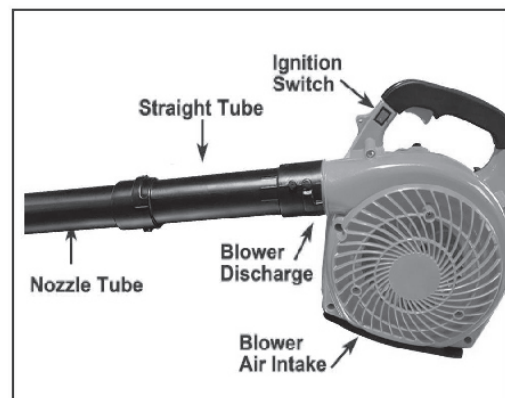
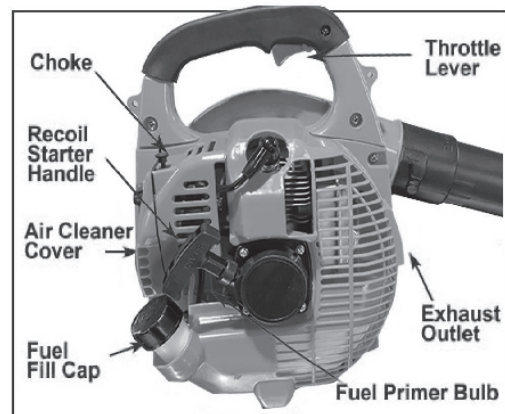

ASSEMBLING THE BLOWER

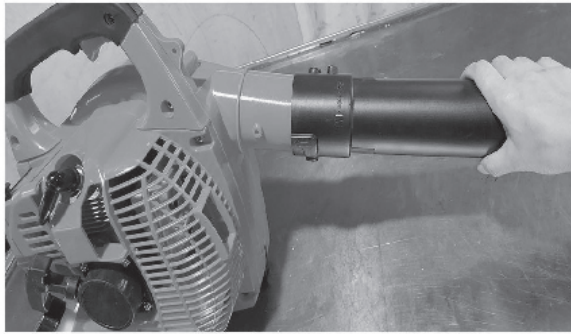

Push the straight tube over the discharge port and locking pin.

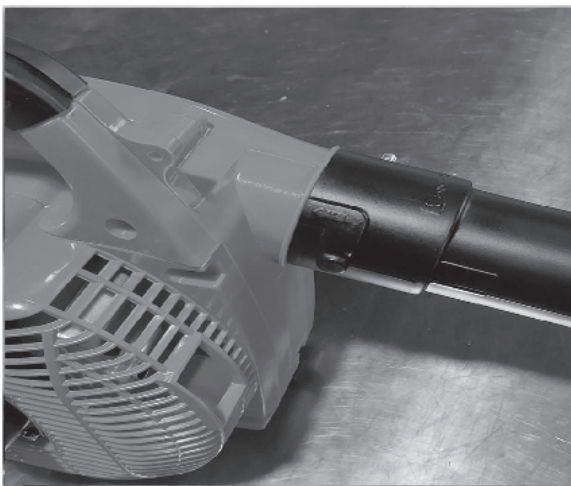

Rotate clockwise to lock.

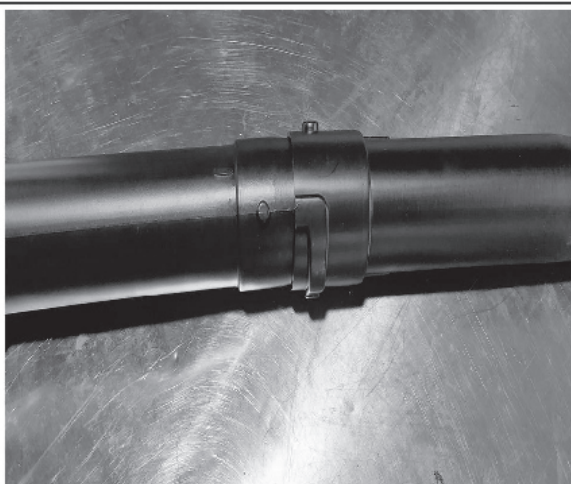

Push the nozzle tube over the straight tube and locking pin.



Rotate clockwise to lock, and the label "this side up" must face up.

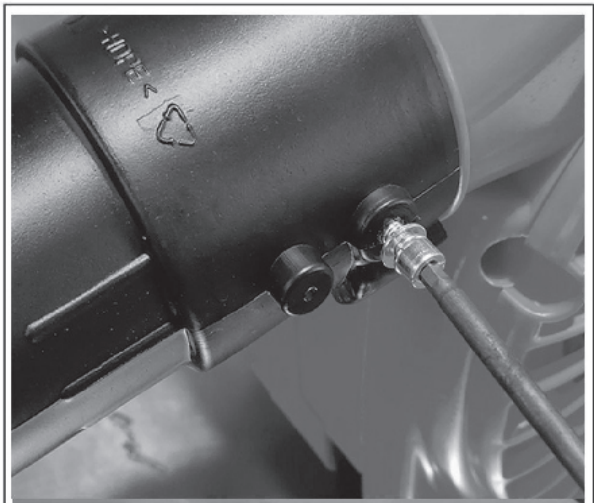

Use the screw M5X10 to fix.

Place the blower upright on the ground or on a sturdy work surface.

1. Grasp the straight tube as shown, and push the tube over the blower discharge port and locking pins.
2. Lock the straight tube to the blower discharge port by rotating the tube as shown.
3. Grasp the nozzle tube with the label "TOP" positioned as shown, and then push the nozzle over the straight tube and locking pins.
4. Lock the nozzle tube to the straight tube by rotating the nozzle tube as shown.

MIXING THE FUEL

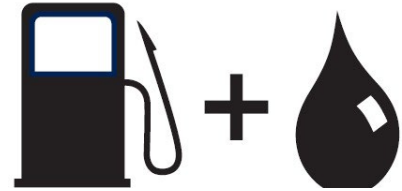

ENGINE FUEL: FUEL TO OIL RATIO 30:1

IMPORTANT! Use good quality air cooled 2-stroke engine oil.

This product is powered by a 2-stroke engine and requires pre-mixing fuel with 2-stroke oil.

1. Use fresh unleaded petrol. You must use 100% synthetic oil specifically made for heavily stressed two-stroke engines.

WARNING! do not use “E10” ethanol fuel blends.

2. Mix the unleaded petrol and oil in an approved container. Never mix fuel directly in the blower fuel tank.

WARNING! Never use any type of pre-mixed fuel/oil direct from fuel stations. This may include special blends intended for use in mopeds, motorcycles, etc.

3. Mix the fuel thoroughly and also each time before fuelling.

4. Always pre-mix in small quantities. Never mix quantities larger than what will be used in a 30 day period.

NOTE! Do not store petrol in plastic containers.

WARNING! Keep fuel out of the reach of children.

FILLING THE FUEL TANK

WARNING. Always shut off the engine before fuelling.

Never add fuel to a machine with a running or hot engine. Move at least 3 metres (10ft) away from the re-fuelling site before starting engine. Do not smoke or use a mobile phone when re-fuelling or operating the blower.

WARNING. Do not use fuel that is more than 2-3 months old. Empty the tank during longer breaks and fill it up again as soon you wish to use the blower again.

IMPORTANT !

A two-position "ON-OFF" switch located on the left of the machine handle grip controls the engine ignition.

Starting Procedure

1. Prime the fuel system by repeatedly depressing the fuel primer bulb until no air bubbles are visible in the fuel discharge line.
2. **Cold Engine Only.** Choke the engine by pulling the choke control to the fully extended position (choke is closed).
3. Place the machine on the ground, and hold the machine handle firmly with your right hand.
4. Pull the starter cord slowly until you feel the starter engage, then...
5. ...start the machine by pulling the starter cord upward rapidly.

If necessary, repeat Step 5 two or three times until the engine starts.

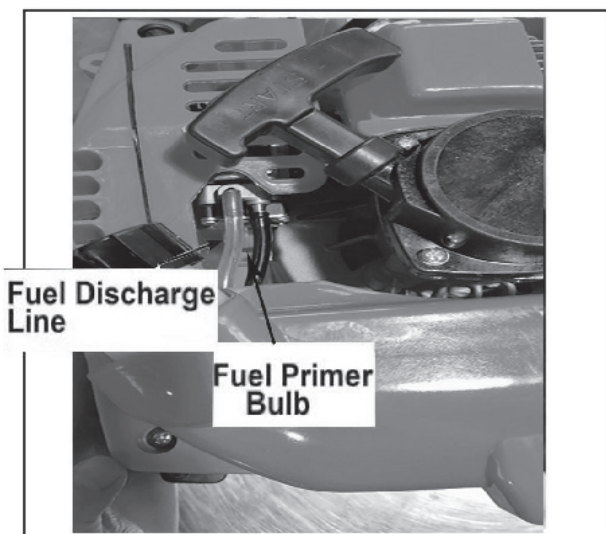

When the engine starts

IMPORTANT !

For maximum vacuum performance and operating life, allow the engine to warm before use.

For maximum vacuum performance and operating life, allow the engine to warm before use.

1. Run the engine at idle speed until operating temperature is reached (2 to 3 minutes).
2. As the engine warms, open the choke gradually by slowly pushing the choke control in to the fully retracted position.
3. The machine should now be ready for use.

If the engine does not start

Repeat the appropriate starting procedures for "hot" or "cold" engine. If the engine still will not start, follow the "Starting a Flooded Engine" procedure (below).

Starting a flooded engine

1. Disconnect the spark plug lead, and use the spark plug wrench to remove the plug in a counterclockwise direction.
2. If the spark plug is fouled or is soaked with fuel, clean or replace the plug as required.
3. Clear excess fuel from the combustion chamber by cranking the engine several times while the spark plug is removed.
4. Install the spark plug and firmly tighten it with the spark plug wrench. If a torque wrench is available, torque the spark plug to 148-165 inch-pounds. Reconnect the spark plug lead.
5. Repeat the starting procedures for "warm engine".
6. If the engine still fails to fire or start, refer to the troubleshooting flowchart at the end of this manual.

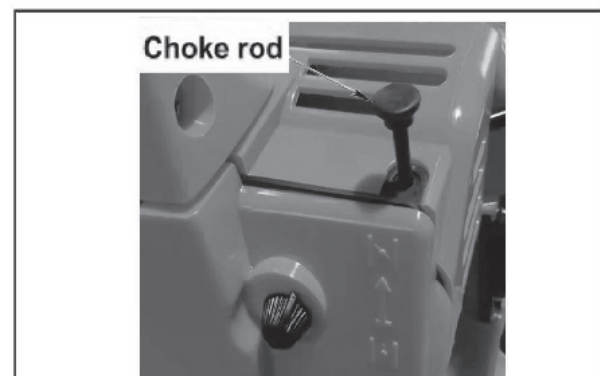

ADJUSTING ENGINE IDLE SPEED

1. Start the engine by following the procedures described on the preceding pages.
2. Run the engine at idle speed until operating temperature is reached (2-3 minutes).
3. Use a screwdriver to adjust the engine idle speed to 2300-2500r/min.

Turn the idle screw clockwise to increase engine idle speed.

Turn the idle screw counterclockwise to decrease engine idle speed.



Idle Speed Adjustment Screw(accessible through cowl louver).

IMPORTANT !

Blower tubes and intake cover must be installed while adjusting engine idle! Engine idle speed will also be affected if either the intake cover or machine tubes are blocked, damaged or incorrectly installed!

STOPPING THE ENGINE

1. Cool the engine by allowing it to run at idle for 2 to 3 minutes.
2. Stop the engine by pulling the ignition switch.

IMPORTANT !

If the engine continues to run with the ignition switch in the "OFF" position, stop the engine by pulling the choke control out to the fully closed position.

A clean and unrestricted airflow is essential to your machine's engine performance and durability! Before attempting any carburetor adjustments, inspect and clean the engine air cleaner as described on page 11 of this manual.

USING THE BLOWER



THINK SAFETY!

In the hands of an experienced operator, the GEB260 can efficiently move a wide variety of debris ranging from grass clippings to gravel. As a general rule, try to operate your machine at the lowest throttle setting necessary to get the job done:

- Use low throttle settings when clearing lightweight materials from around lawns or shrubbery.
- Use medium to higher throttle settings to move lightweight grass or leaves from parking lots or walkways.
- Use full throttle when moving heavy loads such as dirt or snow.



IMPORTANT!

(1) Blower noise increases at higher throttle settings! Always use the lowest throttle setting required to get the job done!

(2) Never operate the blower when visibility is poor.

(3) Always wear eye protection such as face shield or goggles while operating this machine.

(4) Wear a dust mask to reduce the risk of inhalation injuries.

(5) Wear close-fitting clothing to protect your legs and arms.

(6) Wear hearing protection when operating this machine.

(7) Never operate the blower if any component parts are damaged, loose, or missing.

ROUTINE MAINTENANCE



WARNING!

Before performing any maintenance on this machine, stop the engine and disconnect the spark plug wire!



CAUTION!

Dirty or damaged cooling system components may allow the engine to overheat, possibly causing serious engine damage!



CAUTION!

Operating the machine with loose, missing, or damaged components could allow the engine to overspeed, possibly causing serious engine damage!

Daily Maintenance

Remove dirt and debris from the blower exterior.

Inspect the engine, tank, and hoses for possible fuel leaks, and repair as necessary. Inspect the engine cooling fins for accumulations of dirt or debris, and clean as necessary.

Inspect the entire machine for damage, loose or missing components or fastenings, and repair as necessary.

EVERY 10 HOURS (MORE FREQUENTLY IN DUSTY CONDITIONS)

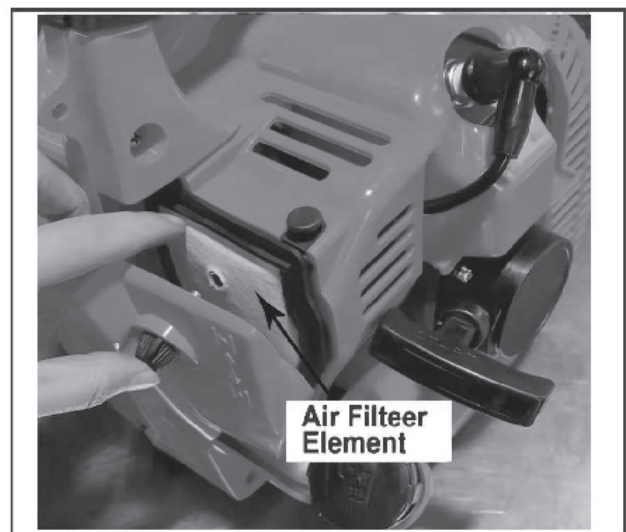

1. Loosen the air cleaner cover retaining screw, and remove the cover and filter element.
2. Inspect the element. If the element is distorted or damaged, replace it with a new one.
3. Wash the element in clean fuel, and squeeze or blow dry. Wash the air cleaner cover in clean fuel, and wipe or blow dry.
4. Install the element and cover, and then tighten the cover retaining screw.

EVERY 10/15 HOURS



Spark Plug (turn counterclockwise to remove)

1. Use the spark plug wrench to remove the spark plug (turn counter-clockwise to remove).
2. Clean and adjust the spark plug gap to 0.6~0.7mm. Replace any damaged or visibly worn plug with a champion RCJ6Y or equivalent.
3. Install the spark plug finger-tight in the cylinder head, and then tighten it firmly with the spark plug wrench. If a torque wrench is available, torque the spark plug to 148-165 inch pounds.



CAUTION

Never allow dirt or debris to enter the cylinder bore!
Before removing the spark plug, thoroughly clean the spark plug and cylinder head area!
Allow the engine to cool before servicing the spark plug!
Cylinder tightening or loosening the spark plug while the engine is hot!
Incorrect spark plug installation can result in serious engine damage.

EVERY 50 HOURS

(More frequently if you note reduced performance)

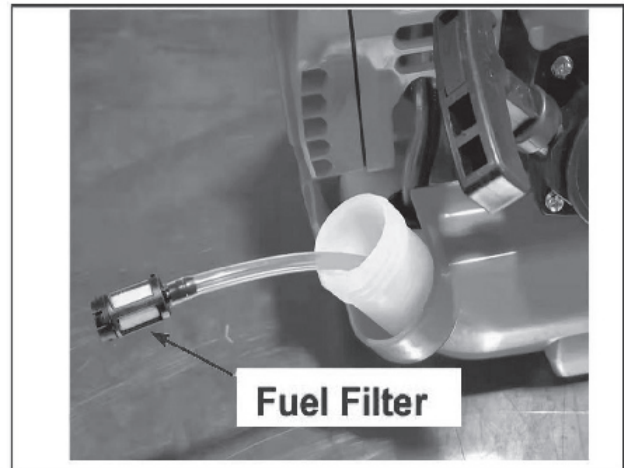

INSPECTION Inspect the entire machine and tubes for damage, including loose or missing components, and repair as necessary.

SPARK PLUG Replace the spark plug with a champion L9T(LD), gapped to (0.6~0.7)mm.

FUEL FILTER Use a wire hook to extract the fuel filter from inside the fuel tank, and then remove and wash the filter element in clean fuel. Before reinstalling the filter, inspect the condition of the fuel line. If damage or deterioration is noted, the vacuum should be removed from service until it can be inspected by a trained service technician.

COOLING SYSTEM Remove the engine cover (as described under "Spark Arrestor"), and use a wood or plastic scraper and a soft brush to remove dirt and debris from the cylinder fins and crankcase.

SPARK ARRESTOR MAINTENANCE

Hard starting or gradual loss of performance can be caused by carbon deposits lodged in the spark arrestor screen. For maximum performance, the spark arrestor screen should be periodically cleaned as follows:

NOTE

- Turn the idle screw clockwise to increase engine idle speed.
- Turn the idle screw counter clockwise to decrease engine idle speed.

IMPORTANT Blower tubes and intake cover must be installed while adjusting engine idle! Engine idle speed will also be affected if the intake cover or blower tubes are blocked, damaged or incorrectly fitted.

TROUBLE SHOOTING

Power loss or sudden stopping of the engine

- Check whether the fuel tank is empty.
- There is water in the mixture. Drain and rinse the fuel system with petrol.
- The air filter is dirty. Clean the air filter.

Starting a flooded engine

- Disconnect the spark plug lead and use the plug wrench to remove the spark plug in a counter clockwise direction.
- If the spark plug is fouled or is soaked with fuel, clean or replace the plug as required.
- Clean excess fuel from the combustion chamber by cranking the engine several times while the spark plug is removed.
- Install the spark plug and firmly tighten it with the spark plug wrench.
- Repeat the starting procedure as if the blower was already warm.

STORAGE (30 DAYS OR LONGER)

- **CLEANING** - Thoroughly clean the blower exterior.
- **INSPECTION** - Inspect the entire blower and tubes for damage, including loose or missing components, and repair as necessary.
- **FUEL** - Drain the fuel tank, and then clear the carburettor and lines by running the blower until it stops from lack of fuel.
- **LUBRICATION** - Remove the spark plug, and then pour approximately Tea spoon of 2 stroke oil into the cylinder through the spark plug hole. Before reinstalling the spark plug, pull the recoil starter 2 or 3 times to distribute the oil over the cylinder walls.
- **AIR CLEANER** - Remove, clean, and reinstall the filter element as described under "BEFORE EACH USE"
- **STORAGE** - Store the blower in a clean, dry, dust-free environment.

SPECIFICATIONS

Engine Type..... 2 cycle air cooled gas engine, vertical cylinder

Bore & Stroke..... 34 x 28 mm

Fuel.....Unleaded fuel/oil mixture (30):1

Carburettor.....Diaphragm-type with primer pump

Ignition All transistor electronic ignition system

Spark plug..... L8RTC or Equivalent

Fuel Tank Capacity..... 0.65L

Air Cleaner Type.....Semi-wet

Weight (dry with blower tubes)4.8kg



Some experts believe the incorrect or prolonged use of almost any product could cause serious injury or death. For information that may reduce your risk of serious injury or death, consult the points below and additionally

- Consult all documentation, packaging and product labelling before use. Note that some products feature online documentation which should be printed and kept with the product.
- Check product for loose / broken / damaged / missing parts, wear or leaks (if applicable) before each use. Never use a product with loose / broken / damaged / missing parts, wear or leaks (if applicable).
- Products must be inspected and serviced (if applicable) by a qualified specialist every 6 months assuming average residential use by a person of average weight and strength, above average technical aptitude, on a property matching average metropolitan specification. Intended use outside these guidelines could indicate the product is not suitable for intended use or may require more regular inspection or servicing.
- Ensure all possible users of the product have completed an industry recognized training course before being given access to the product.
- The product has been supplied by a general merchandise retailer that may not be familiar with your specific application or your description of the application. Be sure to attain third-party approval for your application from a qualified specialist before use regardless of prior assurances by the retailer or its representatives.
- This product is not intended for use where fail-safe operation is required. As with any product (take an automobile, aircraft, computer or ball point pen for example), there is always a small chance of technical issues that needs to be repaired or may require replacement of the product or a part. If the possibility of such failure and the associated time it takes to rectify could in any situation inconvenience the user, business or employee then the product is not suitable for your requirements. This product is not for use where incorrect operation or a failure of any kind, including but not limited to a condition requiring product return, replacement, service by a technician or replacement of parts could cause a financial loss, loss of employee time or an inconvenience requiring compensation.
- If this item has been purchased in error after considering the points above, simply contact the retailer directly for details of their returns policy, if required.



Please give us a chance to make it right and do better !

Contact our friendly customer service department for help first.

Replacements for missing or damaged parts will be shipped ASAP !



HZKJservice@gmail.com

Contact Us!

Do NOT return this item.

Contact our friendly customer service department for help first.